

COLOR CONTACT IMAGE SENSOR

C2R108

SHEC SHANDONG HUALING ELECTRONICS CO.,LTD.

Torch Road, Hi-Tech. IDZ
Weihai Shandong, China
Tel: 86-631-569-8012
Fax:86-631-568-4988
E-mail: sales@shecl.cn

1. Description

This specification is applied to C2R108 Color Contact Image Sensor module (Color CIS).

2. Scope

This C2R108 is a Color CIS consists of a Rod Lens Array, a color LED light source and an array of linear MOS image sensor.

3. Outline

Item	Specification	Note
Scanning width	108 mm	
Sensor element density	200 DPI	
Effective number of sensor elements	850 elements (Full 864 elements)	8 to 857 th
Scanning speed	Color: 0.25 ×3 msec/line (R/G/IR) Black & White: 0.25 msec/line	
Clock speed	4.0 MHz	Note 1
Rod lens array	Single row	
Light source	Red $\lambda_p = 630\text{nm} \pm 15\text{nm}$ 60mA Green $\lambda_p = 520\text{nm} \pm 15\text{nm}$ 60mA IR $\lambda_p = 940\text{nm} \pm 20\text{nm}$ 60mA	LED At least two LED vendors.
Power supply	+5V x 80 mA	
Data output	1 analog output	Synchronous
Block diagram	Figure 5	
Dimensions	Figure1	

Note 1) Clock Speed f must satisfy the following status:

$$f > (864 + 88) / \text{tint}$$

f : Clock speed

864 : Full sensor elements number

tint : Scanning speed

4. Image Data Output Characteristics (Ta = 25°C)

The shipment test in SHEC is done on the condition of this table.

In Color Mode

Item	Symbol	Specification			Note
		Red	Green	IR	
DC supply voltage	VDD	+5.0V			Detector, Logic
LED supply voltage	VLED	<3.0V	<5.0V	<5.0V	
LED supply current	ILED	60mA	60mA	60mA	
White image target		0.05 ~ 0.09 OD			
Timing diagram		Figure 7			
Dark output Minimum	Vdmin	1,500 ± 100 mV			4.1
White output Maximum	Vpmax	300 ± 100 mV			4.2
Dark output Uniformity	Ud	Less than Vpmax/2.0			4.3
White output Uniformity	Uep	Less than 50%			4.4
MTF		20% MIN	30% MIN	5%MIN TBC	4.5 71.37 lppi
Linearity	Gamma	1.05 ± 0.05			
Linearity Uniformity	LU	Less than 6 %			4.6

In Black and White Mode

Item	Symbol	Specification			Note
		Red	Green	IR	
DC supply voltage	VDD	+5.0V			Detector, Logic
LED supply voltage	VLED	<3.0V	0V	0V	
LED supply current	ILED	60mA	0mA	0mA	
White image target		0.05 ~ 0.09 OD			
Timing diagram		Figure 11			
Dark output Minimum	Vdmin	1,500 ± 100 mV			4.1
White output Maximum	Vpmax	300 ± 100 mV			4.2
Dark output Uniformity	Ud	Less than Vpmax/2.0			4.3
White output Uniformity	UEp	Less than 50%			4.4
MTF		20% MIN			4.5 71.37 lppi

TBC: To be confirmed later

The output level of image signal like white and dark and MTF is defined at the point of “ts2” which described in section 6.

A test target is set on the reading position as outlined in Figure 1.

4.1 Vdmin

As shown in Figure 2, Vdmin is the minimum in the dark output signal (turning off the LED).

Every other parameters are defined by Vdmin as a reference.

4.2 Vpmax

As shown in Figure 2, Vpmax is the maximum white output signal and is defined by:

$$Vpmax = MAX[Vp(n)]$$

Vp(n) is the output signal of the n-th pixel using a white image target.

4.3 Ud

As shown in Figure 2, Ud is the output signal in the dark (turning off the LED) and is defined by;

$$Ud = Vdmax - Vdmin$$

Vdmax is the maximum output signal of the nth pixel in the dark

Vdmin is the minimum output signal of the nth pixel in the dark

4.4 UEp

UEp is the white output non-uniformity with dark signal subtracted and is defined by:

$$UEp = ((VEpmax - VEpmi) / (VEpmax)) \times 100\%$$

VEpmax = MAX[VEp(n)]; is the maximum effective output signal

VEpmi = MIN[VEp(n)]; is the minimum effective output signal

VEp(n) is the effective output signal of every pixel and is defined by:

$$VEp(n) = Vp(n) - Vd(n)$$

4.5 MTF

MTF is defined by:

$$MTF = MIN\{ [(Vmax - Vmin) / VEp] \} \times 100\%$$

Vmax is the maximum output signal using the MTF image target

Vmin is the minimum output signal using the MTF image target

VEp is the effective output signal .

4.6 Linearity Uniformity

LUg is measured following procedure and defined;

Step1. Test Target

The white image target is used as a test target. This target must not be moved while this test is being operated.

Step2. LED adjustment

Tred, Tgrn, Tir should be adjusted according to Figure 8 procedure.

Step3. Dark and White correction

Dark and White correction must be done for every each pixel.

Step4. LED on time set

Tred, Tgrn and Tir should be changed as following;

Tred/2, Tgrn/2, Tir/2

Step5. Compute LUg

LUg should be computed for each color as;

$$LUg = \sqrt{Dgave - Dgextm}$$

Dgave is the average of Vg(n). Vg(n) should be got more than 8 times sampling.

Step6. LED on time set

Tred, Tgrn and Tir should be changed as followed and compute LUg regarding to Step5;

Tred/4, Tgrn/4, Tir/4

Step7. LED on time set

Tred, Tgrn and Tir should be changed as followed and compute LUg regarding to Step5;

Tred/8, Tgrn/8, Tir/8

4.7 Correction of Dark and White uniformity

For the best performance two points correction (dark and white) is strongly recommended.

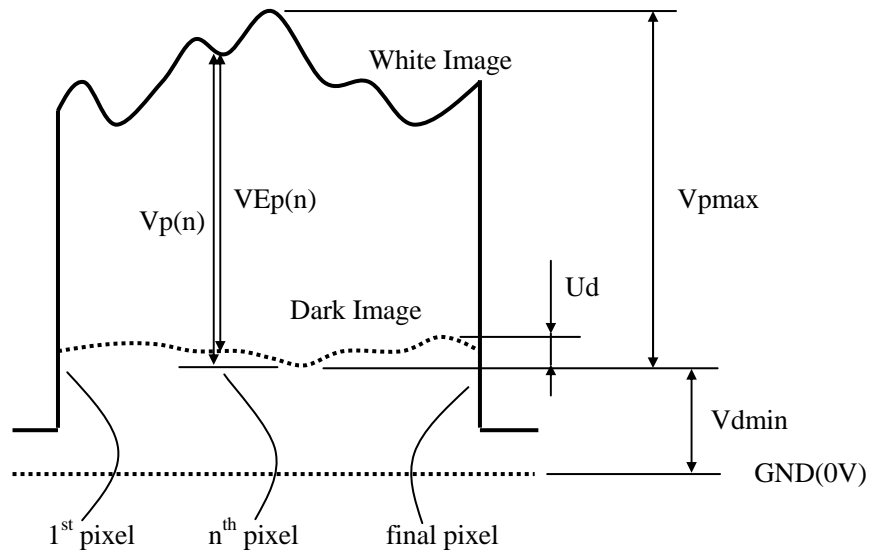

Figure 2. Output Signals Waveform

5. Maximum Rating

Item	Symbol	Specification	Note
DC supply voltage	VDD	+5V ± 0.25V	
Input voltage	VIN	0 ~ VDD+0.3V	SI, CLK
Ambient temperature	Ta	0 ~ +50 °C	Operating
		-20 ~ +60 °C	Non-operating
Ambient humidity		10 ~ 90%RH	Avoid a build up condensation
Maximum operating Temperature		65 °C 30minuts MAX	

LED

Parameter	Symbol	Red	Green	IR	Notes
DC Forward Current	IF	60 mA	60 mA	60 mA	
Pulse Forward Current	IFP	60 mA	60 mA	60 mA	
DC Reverse Voltage	VR	5 V	5V	5V	

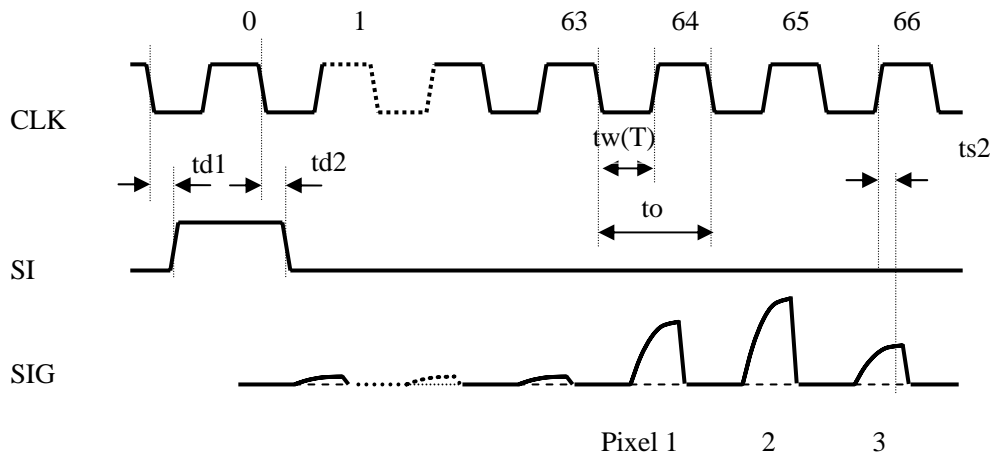

Figure 3. Duty Ratio vs Allowable Forward Current

6.Electrical Characteristics (Ta = 25 °C)

Item	Symbol	Condition	Specification			Unit
			Min.	Typ.	Max.	
DC Supply Voltage	VDD	GND reference	4.75	5.0	5.25	V
DC Supply Current	IDD	VDD = 5V		44	80	mA
LED Forward Voltage	V _{Fred}	IF=30mA	2.1	2.3	2.5	V
		IF=40mA	2.1	2.4	2.6	V
		IF=60mA	2.3	2.5	2.7	V
	V _{Fgreen}	IF=30mA	3.3	3.6	4.0	V
		IF=40mA	3.4	3.8	4.1	V
		IF=60mA	3.6	4.0	4.4	V
	V _{Fir}	IF=30mA	1.2	1.4	1.5	V
		IF=40mA	1.2	1.4	1.6	V
		IF=60mA	1.4	1.5	1.6	V
Input voltage (Note 1)	V _{IH}	SI,CLK	3.7			V
	V _{IL}				1.5	V
Input Current (Note 1)	I _{IH}	SI,CLK			±0.1	μA
	I _{IL}				±4.0	μA
Clock frequency	f	CLK	3.9	4.0	4.1	MHz
Clock pulse duty		tw(T)/to; to=1/f	48	50	52	%
SI delay time	td1	SI-CLK	30	40	to/2	ns
	td2	SI-CLK	30	40	to/2	ns
Data output stability time	ts2	CLK-SIG	20	30	40	ns

(Note1) 74HC244 or equivalent is recommended for input signal.



The each pixel's reset time or the blank time should not be used as the reference

Figure 4. Timing Diagram

7.Reliability

The following table satisfies the reliability when the CIS is operated continuously under standard operating conditions as specified in section 4.

Item	Variable Amount (%)	Note
White output	Initial level +10% -20%	1000Hr
	Initial level +10% -30%	5000Hr

8. Precautions before use:**8.1 Glass surface**

The Glass surface should be kept clean. Don't wipe the glass surface with hand. Don't use the CIS module in a dust-polluted environment. If the glass surface gets dirty, wipe the glass surface gently with a clean cloth soaked in alcohol. The glass surface should be wiped very carefully.

8.2 Extracting / Inserting the connector

The maximum number of times that the connector should be extracted and connected is 10. If the connector is inserted / extracted more than 10 times, the connector 'burrs' will be eroded, thereby making the connector ineffective.

8.3 Stable operation

(1) The connector pins should not be touched by bare hand or electrostatic charge materials.

(2) Noise

- a. Insert a low frequency noise suppressing capacitor(100uF) between VDD(+5V) and GND. A high frequency noise suppressing capacitor is already integrated into the circuit.
- b. Ensure that the sensor connecting cables are 30cm or less in length. The CLK and GND, SIG and GND and VLED and GLED respectively should form twisted cable pairs.

(3) Latch up

When the supply voltage is higher than the absolute maximum, latch up will cause the sensor to break, even if the voltage is caused by a surge. If the current varies rapidly in the external circuit, or when the power is turned on an off very frequently, ensure that the voltage o each terminal does not exceed the values indicated in below.

(4) LED circuit

As shown in Figure.6 LED circuit has not any resistance. Be careful not to connect the LED circuit to power supply directly without current limit resistors.

(5) Absolute maximum ratings

Item	Symbol	Condition	Specification		Unit
			Min	Max	
Supply Voltage	VDD	GND reference	-0.3	+6.5	V
Input voltage	Vin	SI,CLK	GND-0.3	VDD+0.3	V

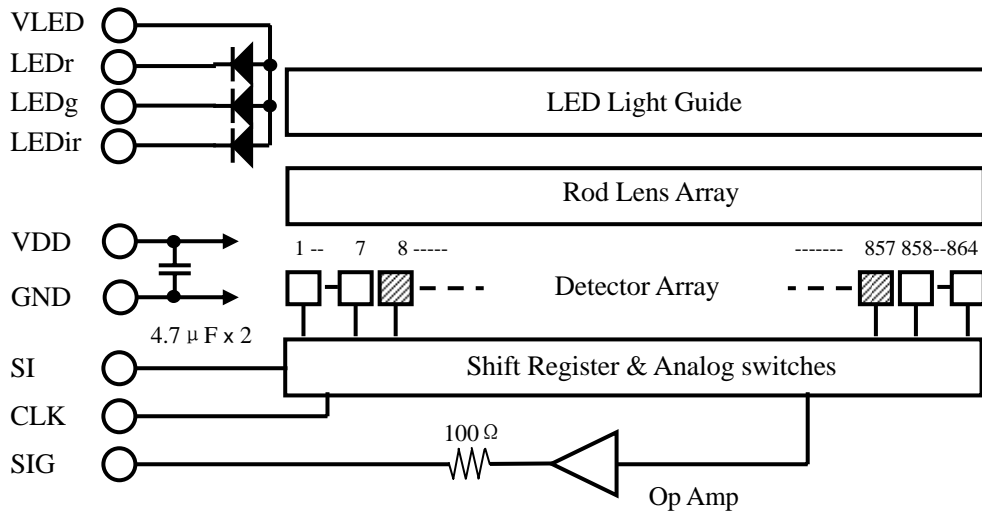

The 8 to 857th element outputs are the actual image signal.

Figure 5. Block Diagram

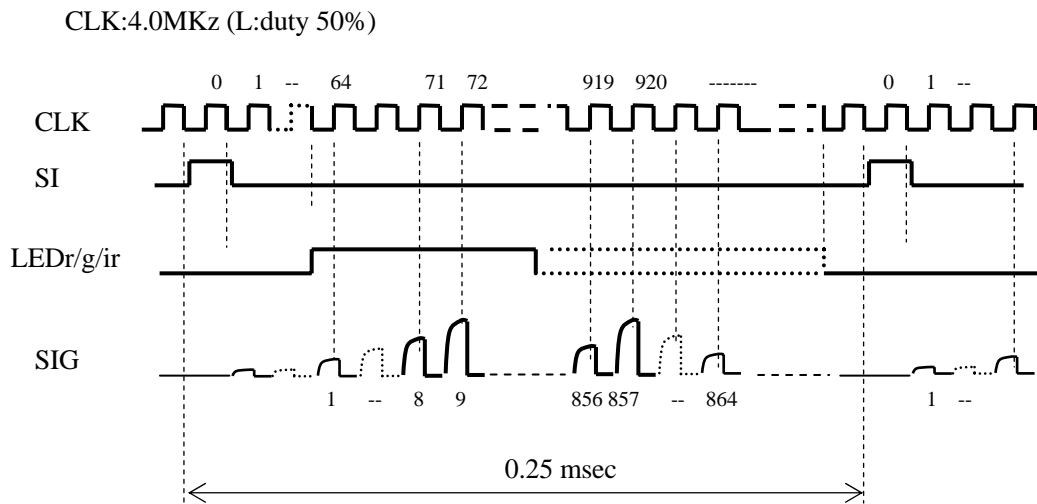
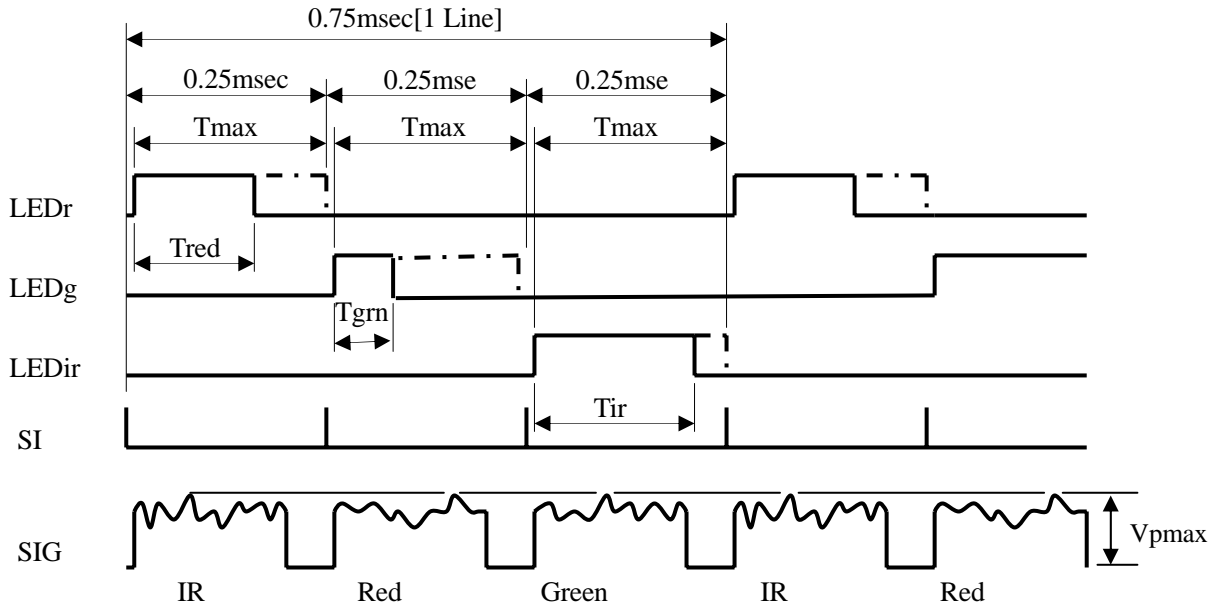

Figure 6. Timing Diagram

(This is the SHEC shipping test condition)

Note After 864th SIG, there are 24bits dummy output.

Color Mode



V_{pmax} and the mean of $V_{Ep}(n)$ of all color have to be adjusted to nearly equal. Refer the adjustment flow at Figure 8.

**Figure 7. Color mode Timing Diagram
(This is the SHEC shipping test condition)**

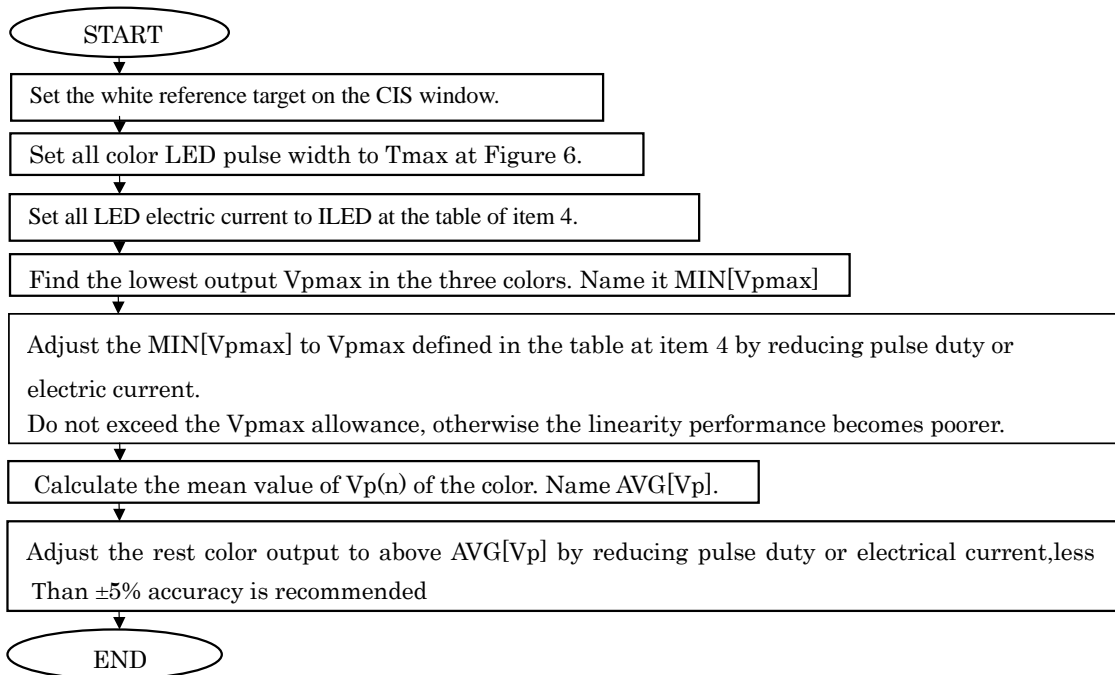
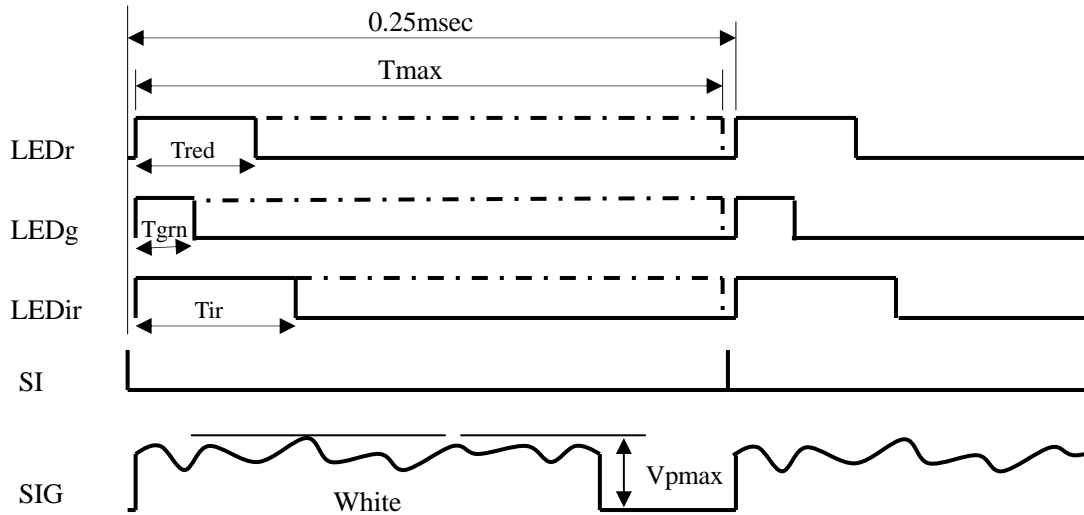

Figure 8. Flow Chart of Color mode Adjustment (This is the SHEC shipping test condition)

□ **B&W Mode**



To get better white light source, refer the adjustment flow at Figure 10.

Figure 9. B&W mode with White Light Source Timing Diagram

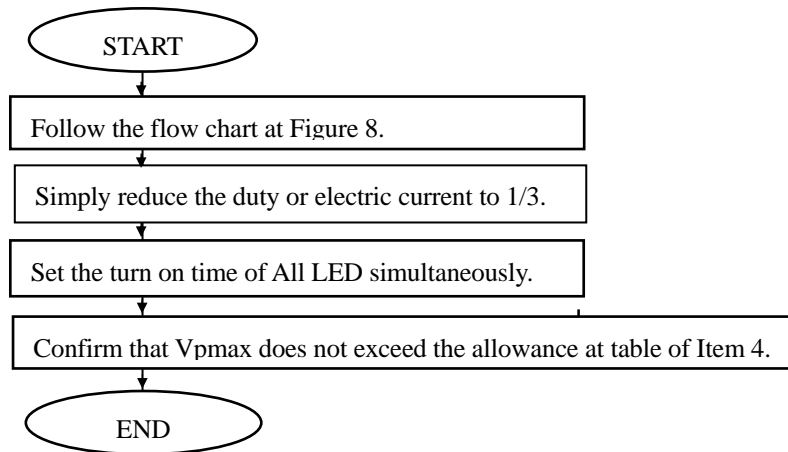
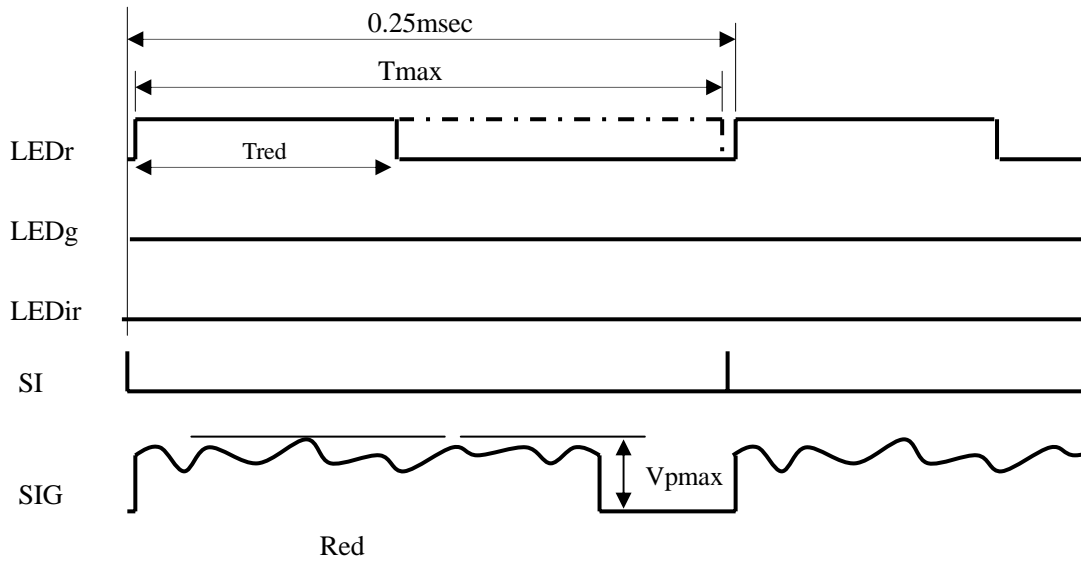

Figure 10. Flow Chart of B&W mode with White Light Source Adjustment

□ **B&W Mode with Mono-Color Light Source**



This is the example for Red mono-color application. Refer the adjustment flow chart at Figure 12.

Figure 11. B&W mode with Mono-Color Light Source Timing Diagram

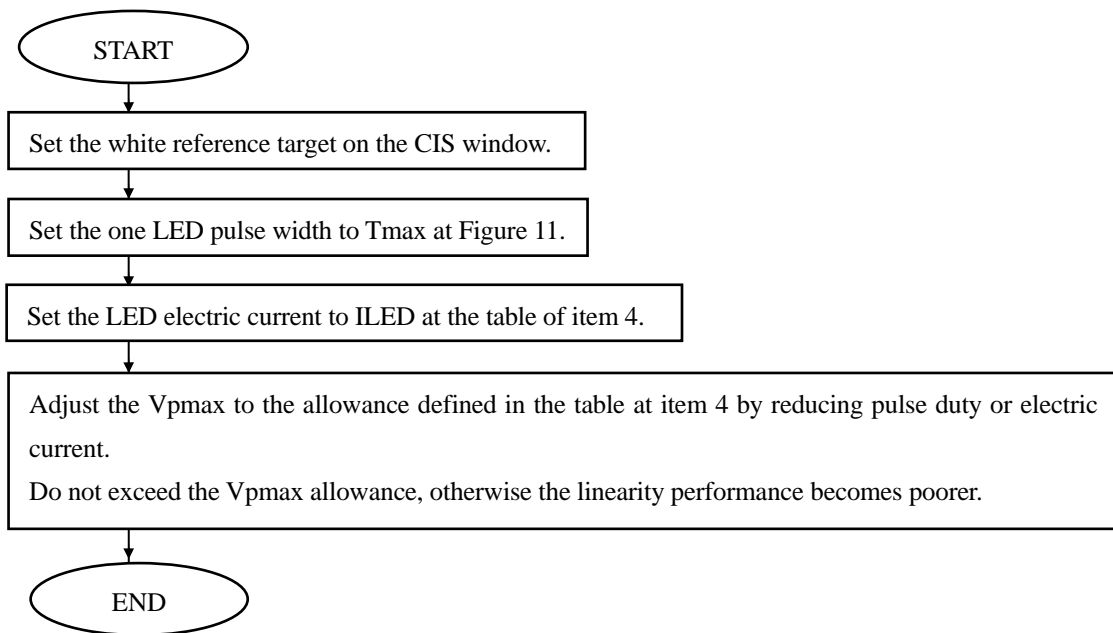

Figure 12. Flow chart for Mono-Color Adjustment

Figure 13. Typical Performance Curve
Unless otherwise specified, Ta=25°C

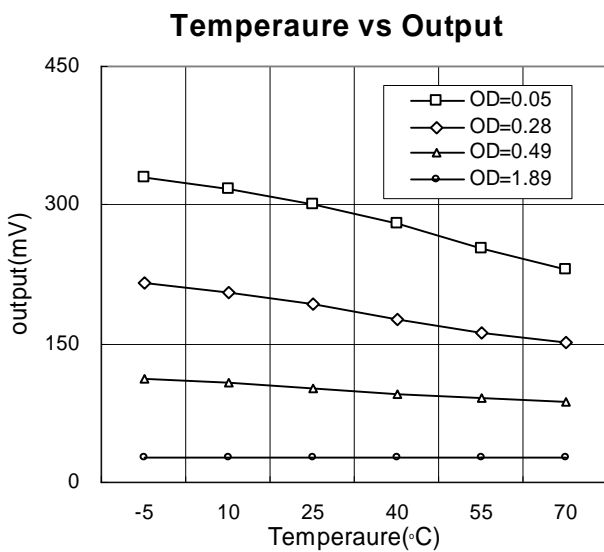
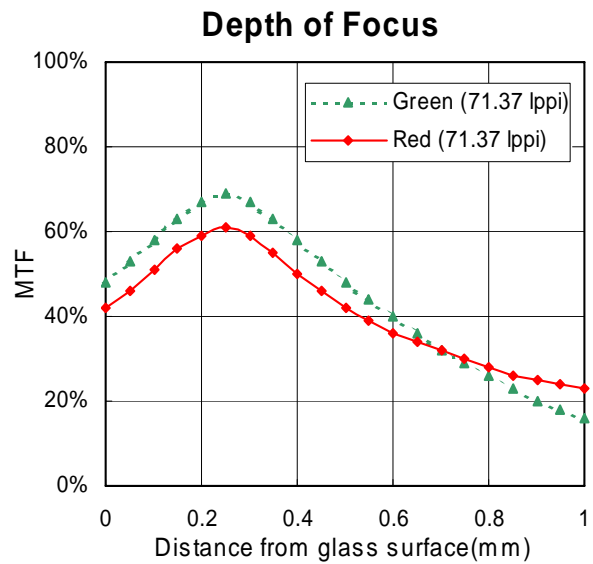
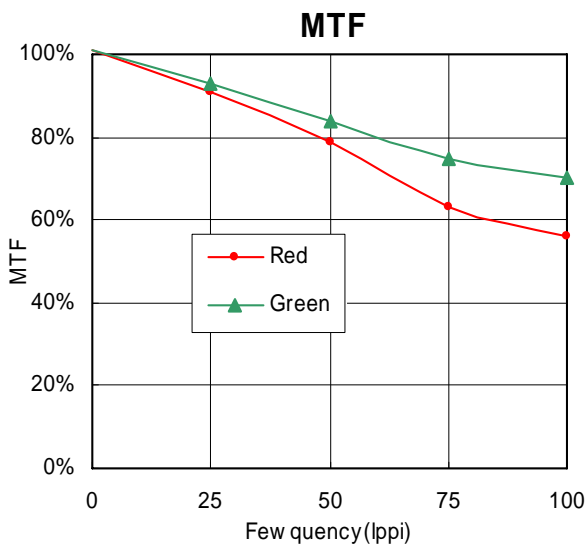
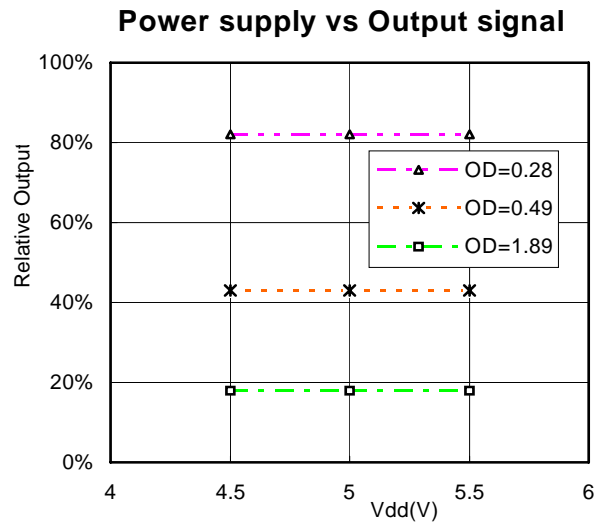
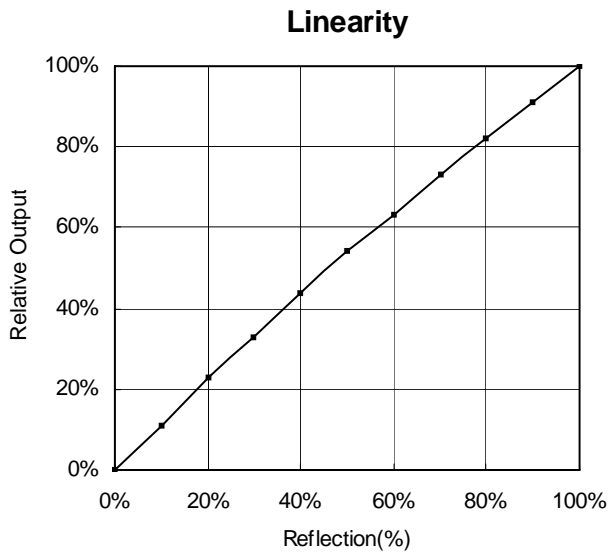

Figure 1 Dimensions

